

Installation instructions for PZ4AL-3007-00, PZ4AL-3008-00
Under Run Protective Shield Fuel Tank

TOYOTA LC 200



LEXUS LX



LC 200 (4.6L; 4,5TD)

LX 570

LX 450d

Model year:

2015

2015

2015

Applicability:

VDJ200L-GMTVZW

Part Number:

Steel: PZ4AL-3007-00
Aluminium: PZ4AL-3008-00



Weight:

Steel: 17.27 kg
Aluminium: 10.25 kg



Installation Time:

30 min

A

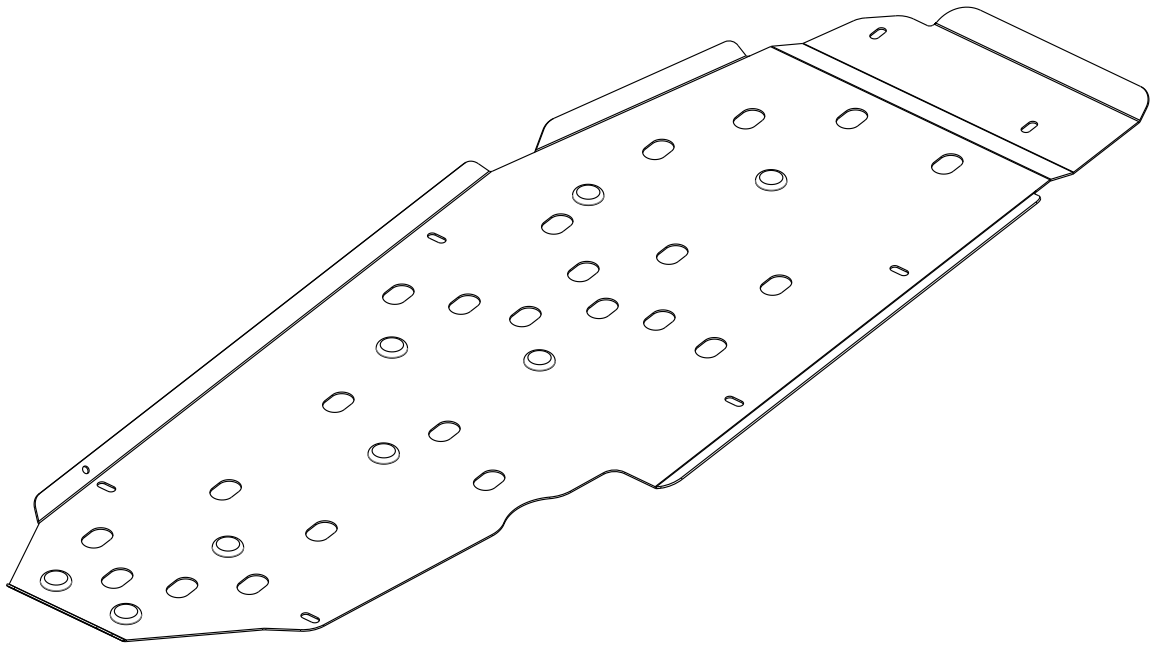

PZ4AL-01588-60

B



1x

C



1x

D

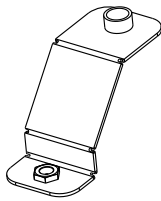

1x

E

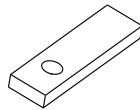

2x

F

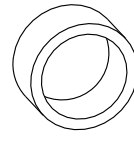

h=10

2x

G1

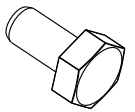

M8x30

5x

G2

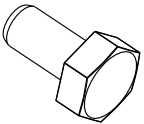

M10x20

3x

G3

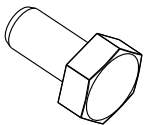

M10x30

2x

H1

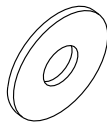

d=8

5x

H2

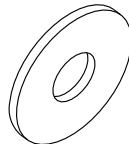

d=10

5x

I1



d=8

5x

I2

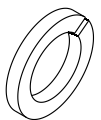

d=10

5x

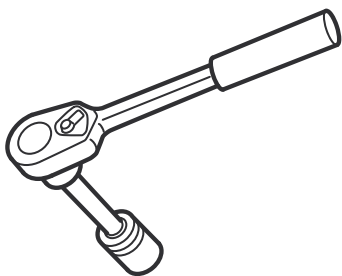

13 mm
17 mm



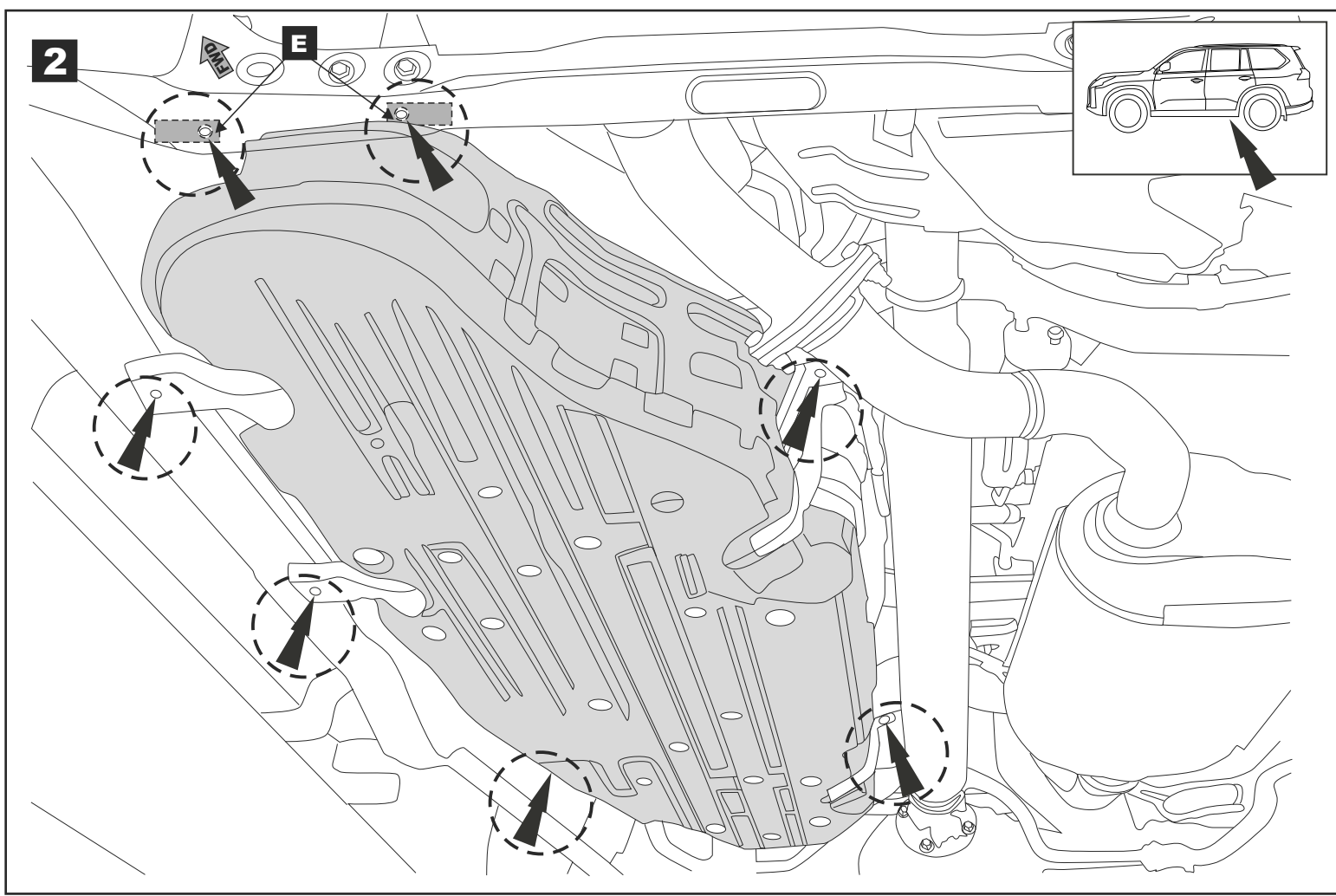
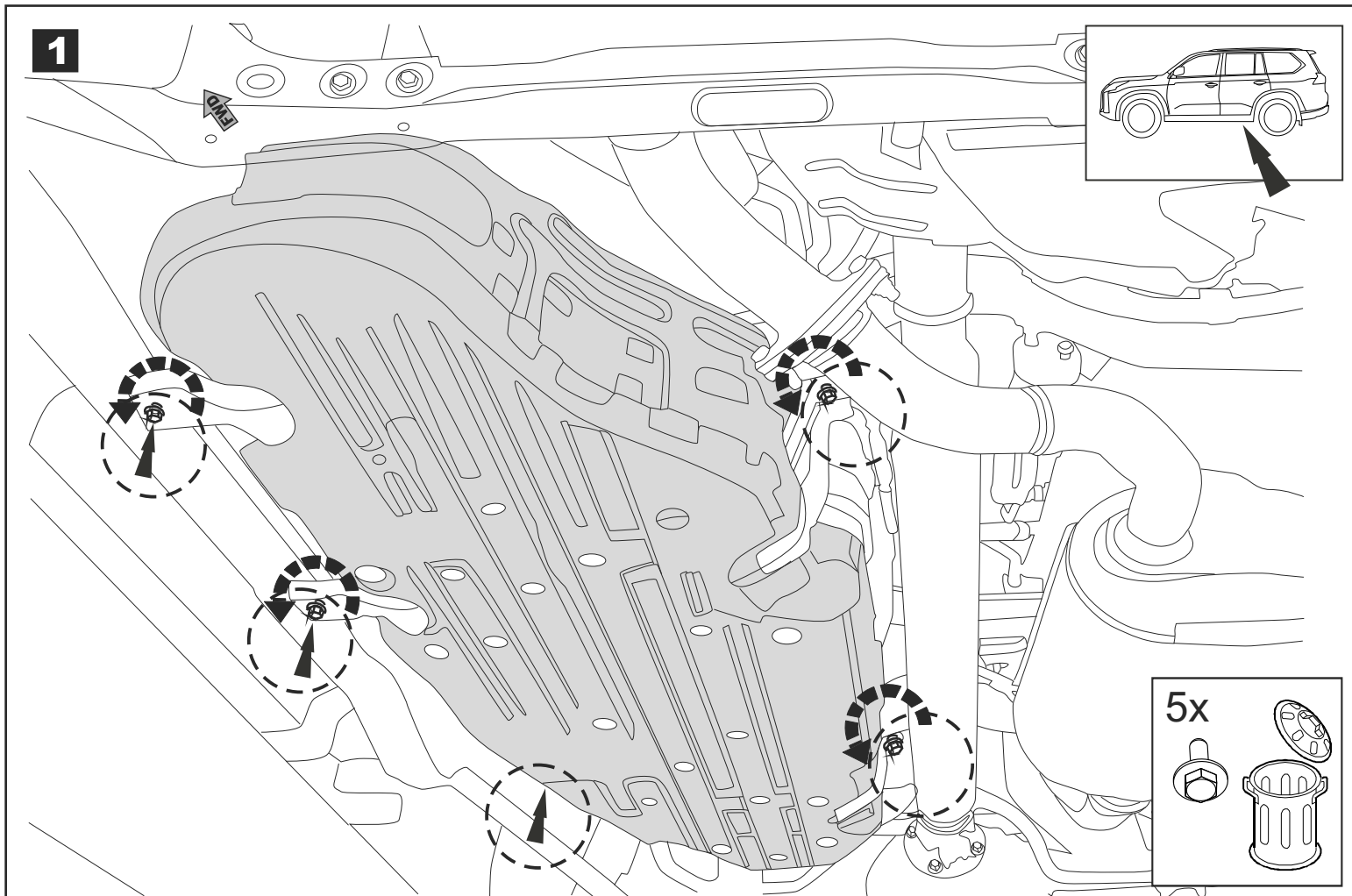

3

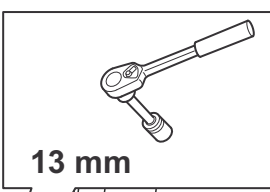
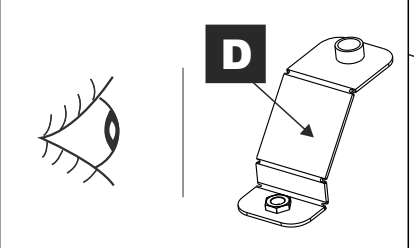
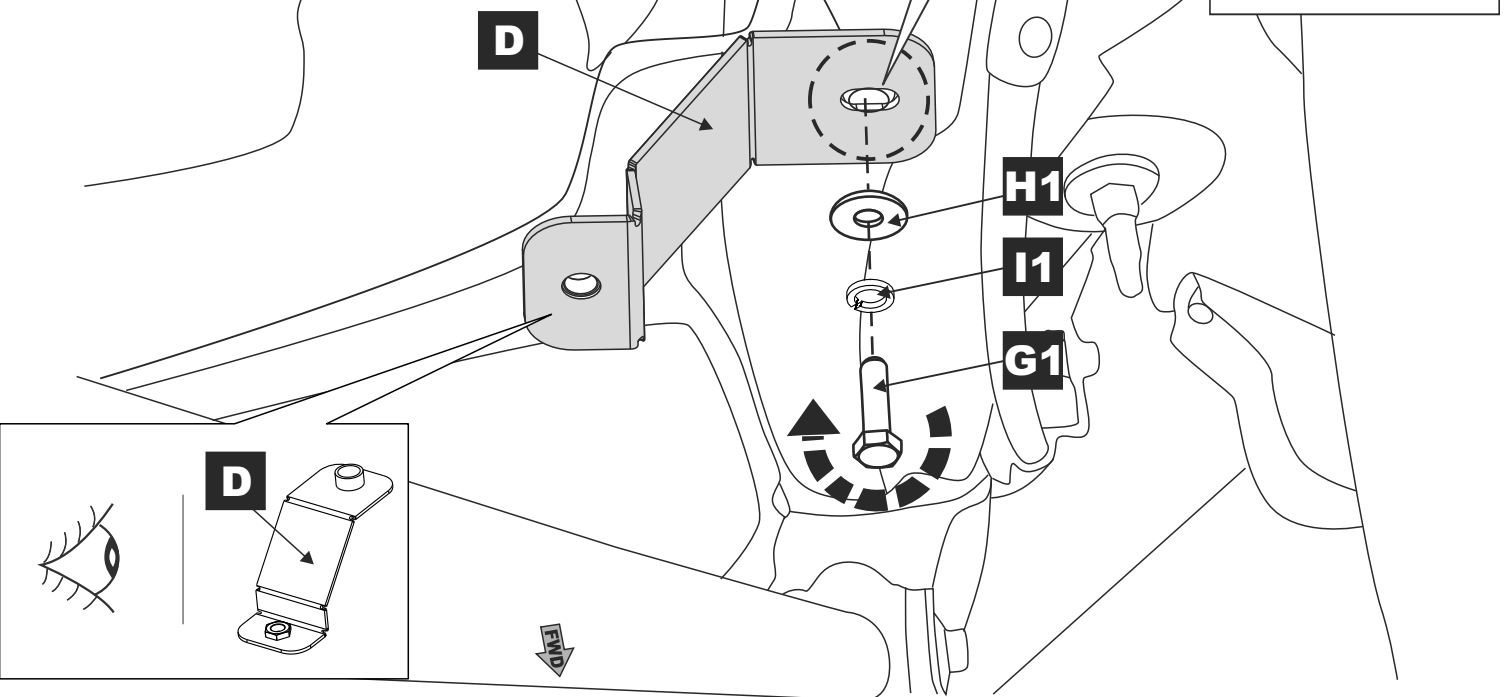
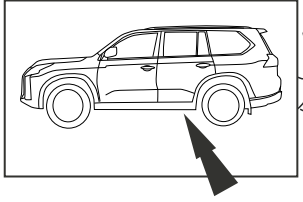

4

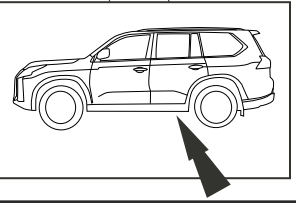
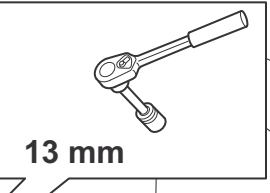
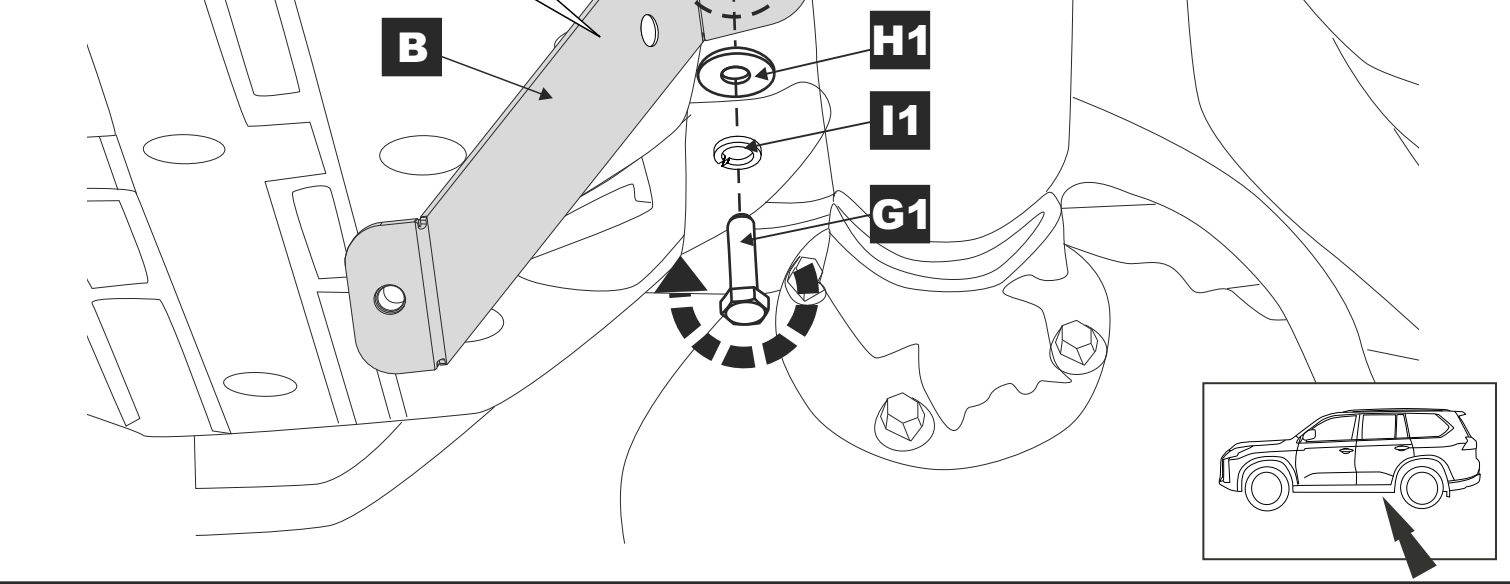
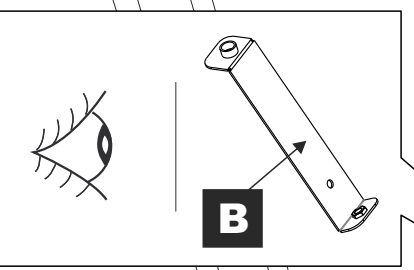

5

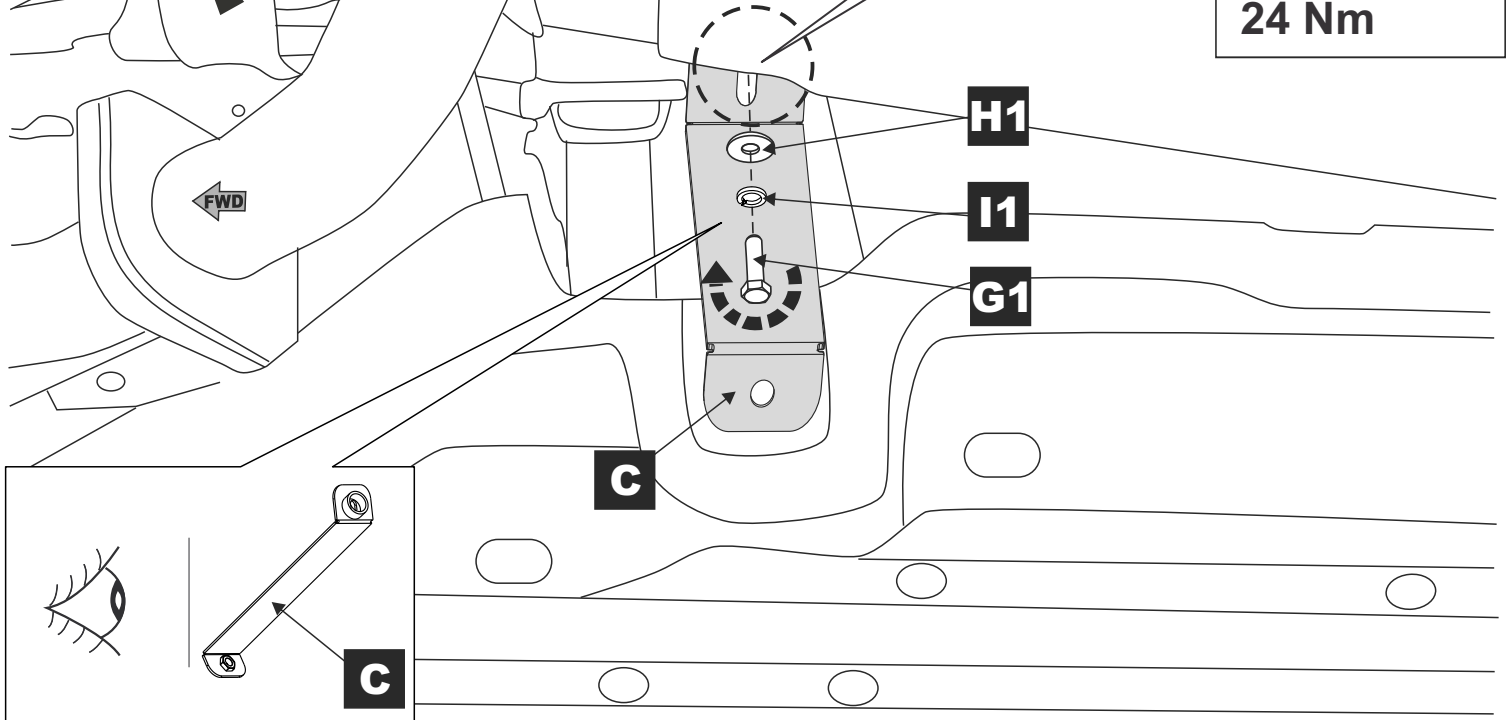
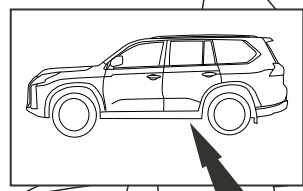

6



A

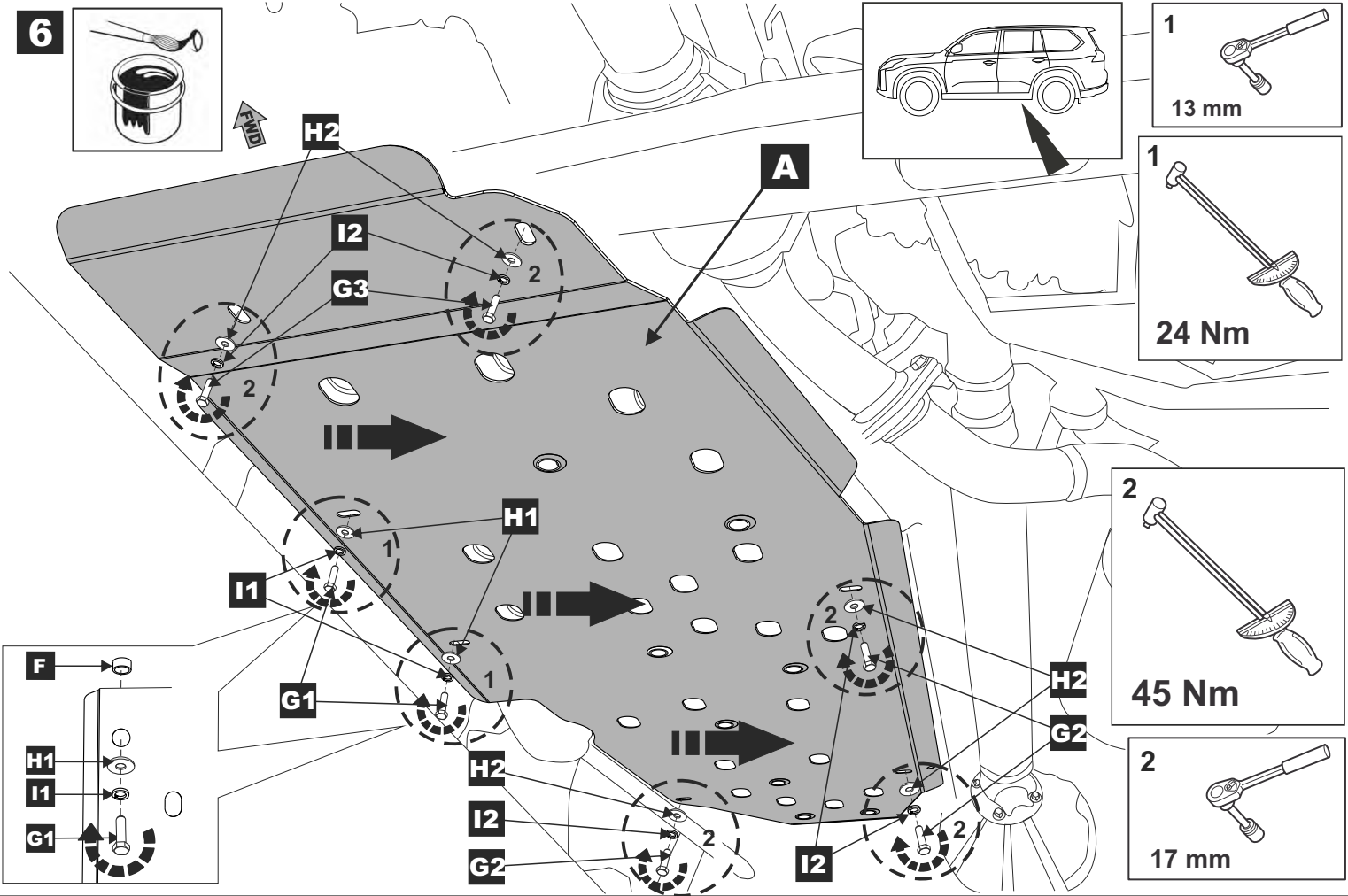
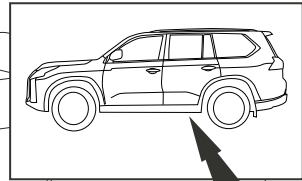

7

END

